

# **DX404 / DX504 / DX604 Four Antenna Diversity Receivers**

**User's Guide & Operating Manual**

**AV010220/1-000  
REV. A3 - 1 April 2005**

Edited by Eli Weinstein

<http://www.avalonrf.com/>

## Table of Contents

1.	General .....	1
	Figure A – Front Panel .....	2
	Figure B – Rear Panel.....	3
2.	Specifications .....	4
	Power Input.....	4
	Figure C – Power Input .....	4
	Antenna Inputs.....	5
	Video Output.....	5
	Audio Outputs .....	5
	Figure D – Audio Output(s) .....	6
	Digital Wireless Link Data Input .....	6
	Figure E – Digital Wireless Link Data Input.....	6
	Digital Wireless Link Antenna Output .....	6
	Size.....	7
	Weight.....	7
	Figure F – DX604 Mechanical Specifications .....	8
	Inches [mm].....	8
	Figure G – DX604 (Option R) Mechanical Specifications .....	8
	Inches [mm].....	8
	Environmental Conditions .....	9
3.	Operating Instructions .....	10
	Human Interface .....	10
	Front Panel Keypad.....	10
	Front Panel Indicators .....	10
	Front Panel Display .....	10
	Front Panel Interface.....	11
	Operating the DX604 .....	11
	Tuning .....	11
	Frequency scanning .....	12
	Tuner Select.....	12
	Turning ON or OFF the LCD backlight .....	13
	Locking the keypad .....	13
	Setup .....	14
	Tuning the audio sub-carrier frequencies.....	14
	Setting the audio sub-carrier bandwidth .....	14
	Changing the video bandwidth .....	15
	Inverting the polarity of the video output .....	15

	Adding the audio sub-carriers to the video output.....	15
	Assigning an EIN (Electronic Identification Number).....	16
4.	Error conditions and Prompts.....	17
	Power fault indicator.....	17
	Battery-low warning.....	17
	Internal errors.....	17
	Keypad entry errors.....	17
5.	Ordering Information.....	18
	Optional features.....	19
	Optional accessories.....	20
	Figure H – Block Diagram – Basic System w/ Single Receiver.....	22
	Figure J – Block Diagram – Basic System with Four Receivers.....	23
	Appendix A – LCD format.....	24
	Appendix B – Remote Programming Option.....	26
	Appendix C – BIT codes.....	28

## 1. General

The DX404/DX504/DX604 are rugged 4-antenna 'true' diversity video and audio receivers intended for demanding high end video applications.

The DX404 NTSC model tuning range is from 56MHz to 802.25MHz

The DX404 PAL model tuning range is from 56MHz to 860MHz.

The DX504 tuning range is from 900 MHz to 928 MHz (2150 MHz with Option 4)

The DX604 tuning range is from 2350 MHz to 2500 MHz (2150 to 2500 MHz with Option 4).

All receivers have the following standard feature:

One FM modulated (AM/VSB for DX404) video channel

Two (1 for DX404) FM modulated audio channels

And the following optional features:

### **Broadcasting industry options**

- \* Talk back audio channel
- \* Remote control of the receiver via RS232

### **Security industry options**

- \* Serial communication (RS485/RS422) input port for Pan/Tilt/Zoom control
- \* Alarm output
- \* 3 analog telemetry outputs
- \* Remote control of the receiver via RS232

Unless explicitly stated, every reference in this document to the DX604 also implies the DX404 and DX504. The main difference between the models is the frequency range.

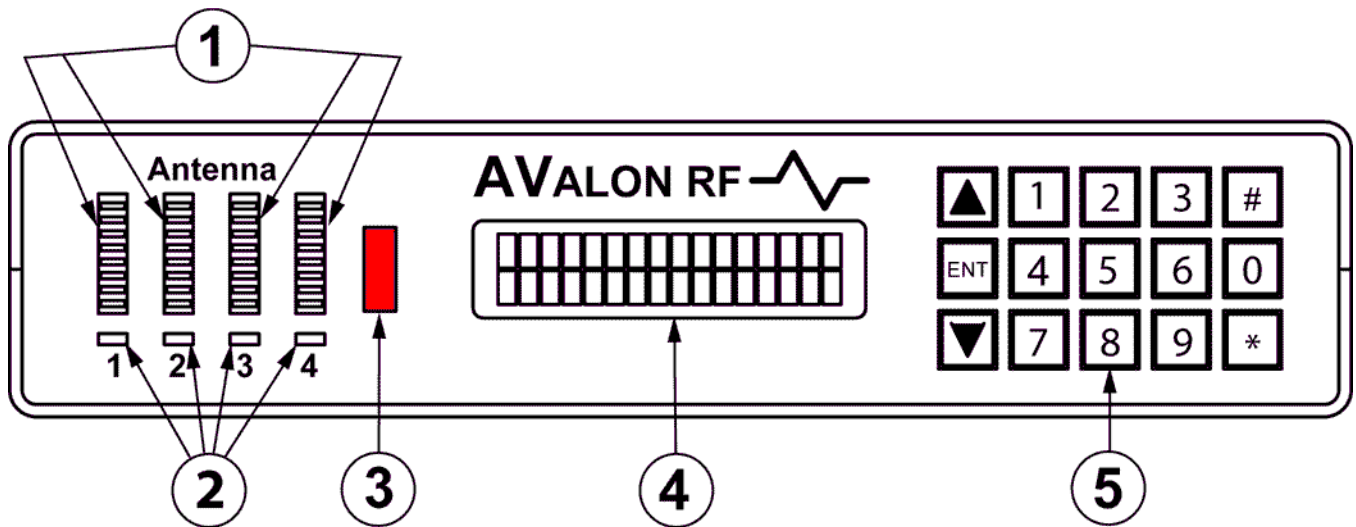

**Figure A – Front Panel**  
DX404/DX504/DX604 Controls, Indicators and Connectors

- 1 Signal Quality Indicators
- 2 Antenna Select LED
- 3 IRDT Receiver
- 4 LCD Display
- 5 Keypad

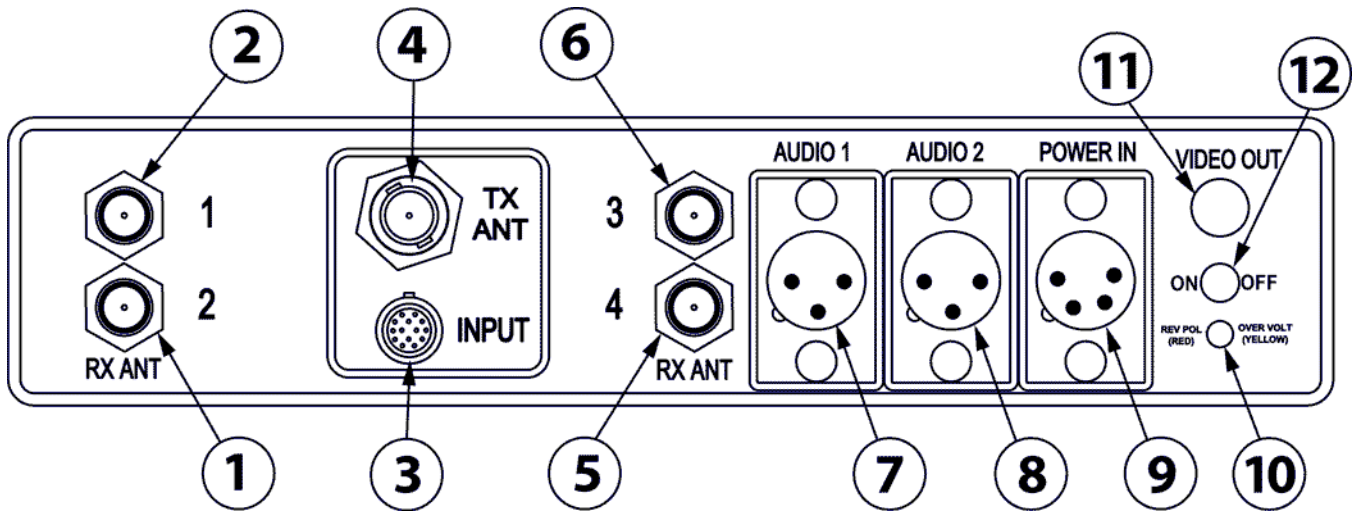

**Figure B – Rear Panel**  
DX404/DX504/DX604 Controls, Indicators and Connectors

- |            |   |
|------------|---|
| 1, 2, 5, 6 | Antenna Inputs (Section 2.2)                            |
| 3          | Digital Wireless Link Interface Connector (section 2.5) |
| 4          | Digital wireless link Antenna Output (section 2.6)      |
| 7, 8       | Audio Outputs (section 2.4)                             |
| 9          | Power & RS232 Input (Section 2.1)                       |
| 10         | Power Fault Indicator                                   |
| 11         | Video Output (Section 2.3)                              |
| 12         | On/Off Switch   |

## 2. Specifications

### 2.1 Power Input (Circle 9 on rear panel).

- a) The power input connector is a XLR 4 pin on the rear panel of the DX604.

Pin 1 – Ground

Pin 2 – RS232 Interface (Transmit)

Pin 3 – RS232 Interface (Receive)

Pin 4 - +9Vdc to +16Vdc

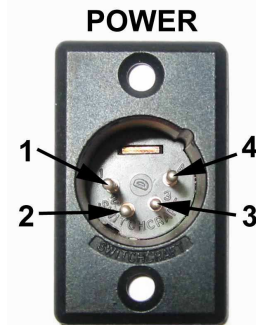

**Figure C – Power Input**

- b) The DX604 operates off a 9Vdc to 16Vdc unregulated voltage source with a ripple of less than 0.5Vp.p.
- c) Input Current is under 1 Amp at an input voltage of 12Vdc.
- d) Power is switched via an ON/OFF mechanical switch.
- e) The DX604 power input is protected against over voltage and reverse polarity.

A bi-color LED on the rear panel indicates the condition. Yellow indicates over voltage and Red indicates reverse polarity.

### **NOTE**

- f) The RS232 interface option on pins 2 and 3 is used to remotely program and setup the DX604 as described in Appendix B.

## 2.2 Antenna Inputs, total of 4 (Circles 1,2,5,6 on rear panel).

- a) DX404: The tuning frequency range is 56MHz-802/860MHz, AM/VSB modulated. The antenna connectors of the NTSC model are "F" type with a 75  $\Omega$  (ohm) impedance. The PAL model has RCA connectors.
- b) DX504: The tuning frequency range is 900-928 MHz, FM modulated. The antenna connectors are "F" type with a 75  $\Omega$  (ohm) impedance.
- c) DX604: The tuning frequency range is 2350-2500 MHz, FM modulated. The antenna connectors are SMA type with a 50  $\Omega$  (ohm) impedance.

## 2.3 Video Output (circle 11 on rear panel)

The video output through a 75  $\Omega$  (ohm) BNC connector.

- a) Output is NTSC/PAL/RS170A/CCIR baseband from 20 Hz to 5.5 MHz.
- b) Output amplitude is 1 Vp.p. with negative sync tips of 0.3 Vp.p.

## 2.4 Audio Outputs (Circles 7,8 on rear panel)

Both audio outputs are XLR 3 pin connectors located on the rear panel.

Pin 1 – Ground

Pin 2 – Audio Output (P)

Pin 3 – Audio Output (N)



**Figure D – Audio Output(s)**

Output is 1 V (peak to peak) into 600  $\Omega$  (ohm), balanced.



## 2.5 Digital Wireless Link Data Input.

The digital wireless link input connector is a LEMO type ECG1B3147CLL or equivalent. The mating connector is a FGG1B314CLAD62

The connector pin-out is:

Pin		Pin	
1	Speaker Left	8	Telemetry 1
2	Microphone	9	Telemetry 2
3	Speaker Left	10	Telemetry 3
4	Microphone Bias	11	Ground
5	RS485 I/O "A"	12	Ground
6	RS485 I/O "B"	13	N/C
7	Alarm	14	N/C

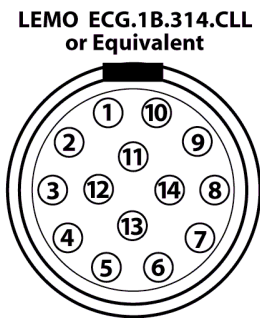

**Figure E – Digital  
Wireless Link  
Data Input**

## 2.6 Digital Wireless Link Antenna Output

The antenna output is a BNC antenna with 50  $\Omega$  (ohm) impedance.

## 2.7 Size

The DX404/DX504/DX604 are available in two configurations:

Configuration	Dimensions
Single DX604 (See Figure F)	<u>Without Removable Hood</u> 8.5" W x 1.75" H x 12.125" D 216mm x 45mm x 308mm
	<u>With Removable Hood</u> 8.7" W x 1.9" H x 13.1" D 221mm x 48mm x 333mm
Dual DX604 (Option R) (See Figure G)	17" W x 1.75" H x 12.125" D 432mm x 44.5mm x 308mm

### NOTES

*The DX604 is intended for use in a desktop configuration.*

*The dual DX604 is intended for mounting in a RETMA 19" rack and requires a height of 1U.*

## 2.8 Weight

Description	Desktop (single)	Dual (Option R) Rack mount
Net	4.3 lbs (1.90Kg)	8.5 lbs (3.80Kg)
Shipping weight	8.5 lbs (3.80Kg)	17 lbs (7.6Kg)

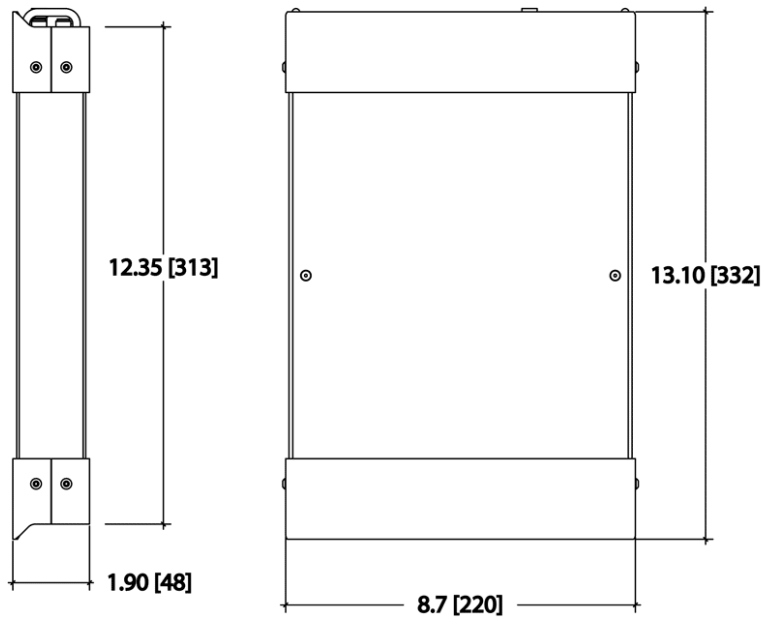

**Figure F – DX604 Mechanical Specifications  
 Inches [mm]**

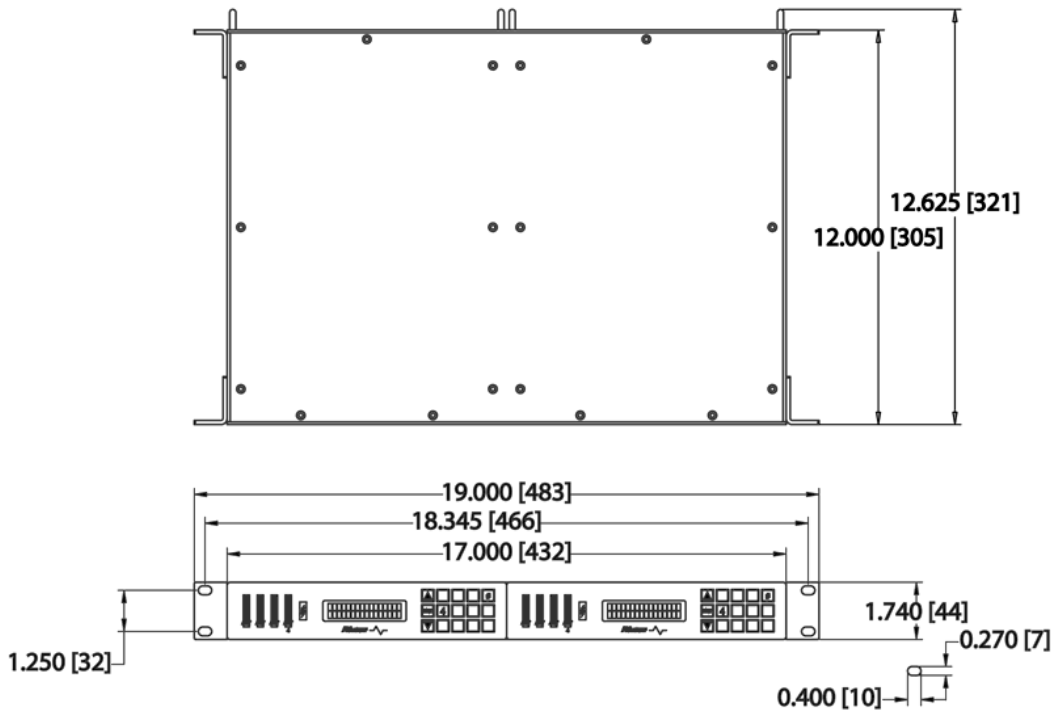

**Figure G – DX604 (Option R) Mechanical Specifications  
 Inches [mm]**

## 2.9 Environmental Conditions.

The DX604 is designed to meet the following environmental conditions:

- a) Operating temperature -4° to 122° F  
(-20° to 50° C)
- b) Storage temperature -13° to 150° F  
(-25° to 65° C)
- c) Vibration 1.5G, from 10Hz to 2KHz, sine wave, three axis
- d) Shock 15G, 25msec, half sine wave, three axis
- e) Humidity 5 to 95%, non-condensing
- f) Inclination Any
- g) Altitude -1500 feet to 15,000 feet  
(-450 meter to 4,500 meter)

### 3. Operating Instructions

#### 3.1 Human Interface.

##### 3.1.1 Front Panel Keypad (Circle 5 on figure A)

All manual setup functions are entered via the keypad.

##### 3.1.2 Front Panel Indicators (Circles 1,2 on figure A).

The DX604 front panel includes the following indicators:

- a) Signal quality indicators for each antenna via an 8 segment LED bar graph. The higher the illuminated LED, the better the signal from the antenna.
- b) Antenna select LED. One Green LED for each antenna. The antenna LED indicates which of the antennas has been selected for its best video.

##### 3.1.3 Front Panel Display (circle 4 on figure A)

The DX604 has a 2 line LCD display, each line capable of displaying up to 16 alphanumeric characters.

CH #39	NTSC
01RANVL	

**Typical DX404 display**

2407.50N	6W0	6W5
01RANVL		

**Typical DX504/DX604 display**

The top line of the LCD displays the frequencies of the video carrier and of the two audio sub-carriers (on the DX504/DX604 only) and the channel number on the DX404. The format of the second line is explained in Appendix A.

The display can be turned ON or OFF (see section 3.2.4).

### 3.1.4 Front Panel Interface

The DX604 has an optional IRDT serial interface, capable of communicating with a PDA at a distance up to 3 feet.

## 3.2 Operating the DX604.

The commonly used receiver commands are:

- \* Tuning
- \* Frequency scanning
- \* Tuner select (Excluding tuners from the diversity)
- \* Turning the display on or off
- \* Locking the keypad.

### 3.2.1 Tuning

<FREQ> <ENTER> tunes in to the desired frequency. The <\*> key is used as a decimal point.

The DX404 NTSC model tuning range is from 56MHz to 802.25MHz

The DX404 PAL model tuning range is from 56MHz to 860MHz.

The DX504 tuning range is from 900 MHz to 928 MHz (2150 MHz with Option 4).

The DX604 tuning range is from 2350 MHz to 2500 MHz (2150 to 2500 MHz with Option 4).

E.G.:

802\*25<ENTER> tunes a DX404 to 802.25MHz (Channel 69)

912<ENTER> tunes a DX504 to 912MHz.

2412<ENTER> tunes a DX604 to 2.412GHz.

The tuned-in frequency appears on the top left of the LCD as explained in Appendix A.

If <FREQ> is out of the tuning range, the receiver will display "INVALID" and default to the last tuned-in frequency.

E.G.:

912<ENTER> is beyond the tuning range of the DX604 and will be rejected.

#<CHANNEL> <ENTER> tunes in to the desired channel (DX404 only).

The valid channels for the DX404 NTSC model are 2-69.  
The valid channels for the DX404 PAL model are 2-12 and 21-70.

E.G.:

#25<ENTER> tunes a DX404 to channel 25.

### 3.2.2 Frequency scanning.

<UP> tunes to the next higher frequency (or Channel for DX404).  
<DOWN> tunes to the next lower frequency (or Channel for DX404).  
Holding down the <UP> or <DOWN> keys changes the frequency (or channel) repeatedly.

The factory preset step increment/decrement step is 0.25MHz and may be changed by typing the following sequence:

\*92 <STEP> <ENTER>

Where

<STEP> is a 4 digit number from 0025 to 9975, corresponding to a minimum step of 0.25MHz and a maximum of 99.75MHz.

E.G.:

\*92 1 <ENTER> will increment/decrement 1MHz at a time.

\*92 12 <ENTER> will increment/decrement 12MHz at a time.

\*92 0025 <ENTER> will increment/decrement 0.25MHz at a time.

\*92 1225 <ENTER> will increment/decrement 12.25MHz at a time.

### 3.2.3 Tuner Select

The DX604 is factory preset to automatically select one of the 4 tuners (The one with the best signal). The number of tuners participating in the diversity process can be limited via the following function (<TN> is any tuner number from 1 to 4):

\*1# <TN> <ENTER> selects one tuner only.

\*1# <TN> <TN> <ENTER> selects two tuners.

\*1# <TN> <TN> <TN> <ENTER> selects three tuners out of four.

\*1 <ENTER> selects all four tuners (normal mode)

E.G.:

\*1#1 <ENTER> locks the output to tuner 1 and stops the diversity.

- \*1#12 <ENTER> eliminates tuners 3 and 4 from the diversity
- \*1#123 <ENTER> eliminates tuner 4 from the diversity
- \*1 <ENTER> includes all four tuners in the diversity process.

A A/M indication is shown on the LCD display, line 2 as explained in Appendix A. This setting is not saved at power off.

#### 3.2.4 Turning ON or OFF the display.

\*# <ENTER> toggles the display ON or OFF.

#### 3.2.5 Locking the keypad.

This feature is used to prevent accidental change of setup.

- \*077 <ENTER> locks the keypad.
- \*055 <ENTER> unlocks the keypad.

The LCD displays a "L" at the bottom right if the keypad is locked.



### 3.3 Setup.

#### 3.3.1 Tuning the audio sub-carrier frequencies (DX504/DX604 only).

The Audio1 sub-carrier frequency is factory preset to 6 MHz.  
The Audio2 sub-carrier frequency is factory preset to 6.5MHz.

The audio sub-carrier frequencies can be tuned anywhere between 5MHz to 7MHz in increments of 10KHz.

Audio1: \*21# <FREQ> <ENTER>  
Audio2: \*22# <FREQ> <ENTER>

Where <FREQ> is from 500 to 700 (the first digit represents megahertz & the last digit represents 10's of kilohertz), tunes the audio sub-carrier to the desired frequency. If the '#' character and <FREQ> are omitted, the sub-carriers will tune to the factory preset.

E.G.:

\*21# 665 <ENTER> tunes Audio1 to 6.65 MHz.  
\*22# 700 <ENTER> tunes Audio2 to 7MHz  
\*22 <ENTER> tunes Audio2 back to 6.5MHz

#### 3.3.2 Setting the audio sub-carrier bandwidth.

The audio IF bandwidth can be set to **narrow** for 75 KHz deviation or **wide** for 125 KHz deviation.

Audio1: \*211 <ENTER> sets Audio1 bandwidth to Narrow.  
          \*210 <ENTER> sets Audio1 bandwidth to Wide.  
Audio2: \*221 <ENTER> sets Audio2 bandwidth to Narrow.  
          \*220 <ENTER> sets Audio2 bandwidth to Wide.

Selecting an incorrect audio bandwidth results in a low and distorted audio output.

### 3.3.3 Changing the video bandwidth (DX504 only).

The DX404 video bandwidth is factory preset to 5MHz. The DX604 video bandwidth is factory preset to 16 MHz. The DX504 video bandwidth can be field changed from 16MHz to 27 MHz and back.

\*32 <ENTER> changes the video bandwidth to 27 MHz.

\*31 <ENTER> changes the video bandwidth to 16 MHz.

LCD display indication – first line, after carrier frequency.  
“W” alongside the carrier frequency indicates **wide** bandwidth of 27 MHz. “N” indicates **narrow** bandwidth of 16 MHz.

### 3.3.4 Inverting the polarity of the video output.

The DX604 is factory preset to positive video (negative sync).

\*42 <ENTER> sets the video output to negative video.

\*41 <ENTER> restores video output to positive video.

LCD display indication – second line (See Appendix A)  
“N” indicates NORMAL (positive) video. “I” indicates INVERTED (negative) video.

### 3.3.5 Adding the audio sub-carriers to the video output (DX504/DX604 only).

This function extends the diversity architecture above the 4 inputs available on a single DX504/DX604 to 8, 12, and 16 inputs by hooking up two, three or four DX504/DX604 receivers to a DX004 baseband diversity receiver.

\*51 <ENTER> sets the video output to video with no audio.

\*52 <ENTER> sets the video output to video with audio.

LCD display indication – second line (See Appendix A)  
“V” indicates video with no audio.  
“R” indicates video with audio.

## NOTE

Displaying video that has the audio subcarriers on it will show visible noise on the picture.

### 3.3.6 Assigning an EIN (Electronic Identification Number) to the DX604.

Valid only for firmware ver 6.7 and later

This command is used in conjunction with the RS232 option. Multiple DX604's can be controlled with a single RS232 port by using a RS232 to RS485 converter. If this is needed, please contact the factory for details.

Every DX604's EIN is factory preset to "01".

\*8<EIN><ENTER> where <EIN> is a 2 digit number from 01 to 99 assigns EIN as the receiver ID.

\*8<00><ENTER> - clears the id. 00 is NOT a valid EIN number

or

\*8<ENTER>

When ID is set, the second line of the LCD display will show the current ID in NN (refer Appendix B)

When ID is set, prefix all serial commands with the three-byte sequence

<EIN><space>

Example:

If EIN is 09, a command to set frequency to 2379 MHz would be:

09sp2379<ENTER>

where 'sp' is space

## **4. Error conditions and Prompts.**

### **4.1 Power fault indicator.**

The power fault indicator (Circle 10 on the rear panel) illuminates when the input voltage exceeds 24V, or when the input voltage is hooked up in reverse polarity.

### **4.2 Battery-low warning.**

The front panel LCD backlight will blink whenever the power input voltage drops below 10.5V. While in this mode, the receiver is unable to memorize any setup changes.

### **4.3 Internal errors.**

The LCD messages "BIT x" indicate internal errors. The DX604 may need to be serviced. Please call your dealer or AValon RF directly.

Please see Appendix 'C' for an explanation of the errors.

### **4.4 Keypad entry errors.**

When an illegal command or a command with illegal parameters is entered, the message "INVALID" is displayed. See description for specific commands.

## **5. Ordering Information**

**DX404 – Basic System**

**DX504 – Basic System**

**DX604 – Basic System**

Every DX604 comes with the following standard features and accessories.

5.1.1 One DX404 or DX504 or DX604 in a ZIPLOCK ESD bag.

The receiver has one video and two audio channels.

5.1.2 One BX002U 12V low noise regulated AC adapter for 110Vac/60Hz.

5.1.3 A user manual (the one you're reading).

5.1.4 A warranty card.

5.1.5 One reusable carton with foam lining.

## 5.2 Optional features:

- |           |   |
|-----------|---|
| Option 00 | European version.<br>Includes a 230VAC power adapter and calibration for PAL.   |
| Option 01 | Remote programming.<br>The RS232 interface is installed on the power input connector. Consult Appendix B for programming instructions.  |
| Option 02 | Remote synthesizing (DX604 only)<br>This option automatically changes the operating frequency of a TX630 companion transmitter to match the change in tuning frequency of its DX604. It requires Option 11. |
| Option 03 | Dual IF bandwidth (DX504 only)<br>IF bandwidth of 16MHz and 27MHz   |
| Option 04 | Extended tuning range<br>900 MHz – 2.15 GHz (DX504)<br>2.150GHz to 2.500GHz (DX604)   |
| Option 11 | Two way serial communication channel.   |
| Option 31 | Audio talk back<br>Does not work in conjunction with option 11  |
| Option 41 | Alarm output  |
| Option 51 | Telemetry output.   |
| Option 99 | Power to an external LNA (DX504 only)   |
| Option R  | Rack mount adapter (requires two receivers).  |

### 5.3 Optional accessories

#### 5.3.1 Antennas.

Each receiver requires four (4) antennas. Higher antenna gain yields longer range with limitations on reception "viewing angle".

Ordering information:

Description		DX404	DX504	DX604
2dbi	omnidirectional	AX402	AX502	AX602
2dbi	omni circular polarized			AX602R
5dbi	omnidirectional	AX405	AX505	AX605
6dbi	hemispheric patch	AX406	AX506	
9.5dbi	panel antenna			AX609
10dbi	circular polarized(RH) patch			AX610R
10dbi	circular polarized(LH) patch			AX610L
11dbi	log periodic antenna	AX411		
13dbi	panel antenna		AX513	AX613
15dbi	panel antenna			AX615
18dbi	panel antenna			AX618
24dbi	parabolic antenna			AX624

#### 5.3.2 Antenna cables.

These cables connect the receiver to its antennas. If a system requires splitters, these cables connect the antennas to the splitters.

DX604: Times Microwave LMR-240 50 Ω (ohm) or equivalent are recommended for runs up to 30ft and LMR-400 50 Ω (ohm) for runs from 20ft to 50ft.

Ordering Information:

Length	DX404/DX504 F-F/75Ω (ohm)	DX604 N-SMA/50Ω (ohm)
5'	CBLFF-5	CBLNS-5
15'	CBLFF-15	CBLNS-15
30'	CBLFF-30	CBLNS-30
50'	CBLFF-50	CBLNS-50

### 5.3.3 Antenna cables for the Digital Wireless Link (DWL)

The DWL antenna cable is a BNC to BNC cable with RG58 cable.

### 5.3.4 Splitters

When a set of four antennas feeds more than one receiver, it is convenient to split the signal from each antenna to all receivers at the same location.

There are two types of splitters: Passive and amplified. Passive are lower cost and adequate for short range. Amplified splitters are costly but offer better sensitivity.

Ordering information:

Splitter type	DX404/DX504 (F-F)	DX604 (SMA-SMA)
1 to 2 (two DX..4)	SP2F	SP2S
1 to 3 (three DX..4)	SP3F	SP3S
1 to 4 (four DX..4)	SP4F	SP3S
1 to 8 (eight DX..4)	SP8F	SP8S

### 5.3.6 Splitter to receiver cables.

The use of splitters requires jumper cables from every splitter output to every receiver antenna input. For a four receiver

Ordering information:

Number of DX..4 Receivers	Number of cables	DX404/DX504	DX604
2	8	CBLFF-2	CBLSS-2
3	12	CBLFF-2	CBLSS-2
4	16	CBLFF-2	CBLSS-2



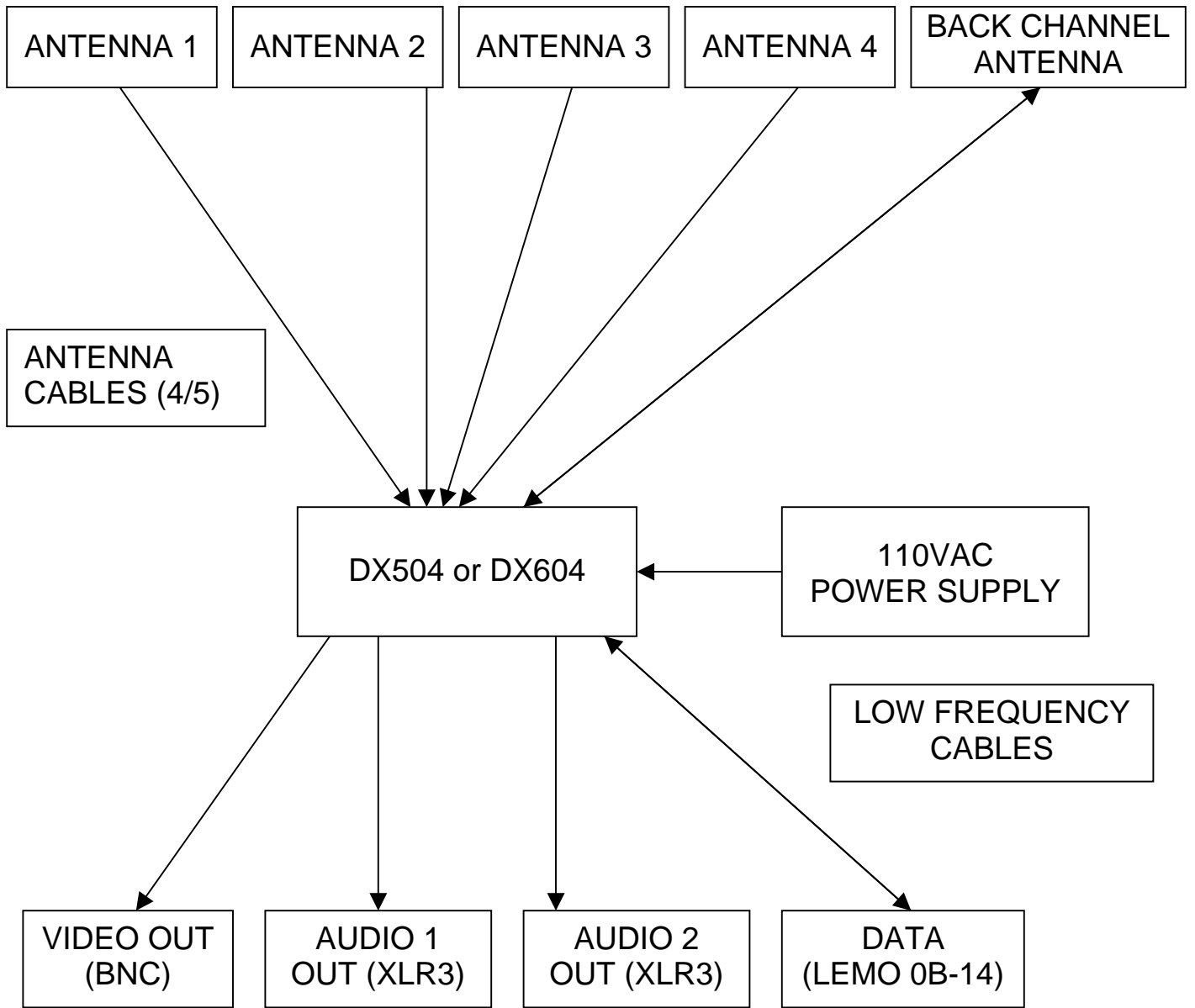

**Figure H – Block Diagram of Basic System with a Single  
DX404/DX504/DX604 Receiver**

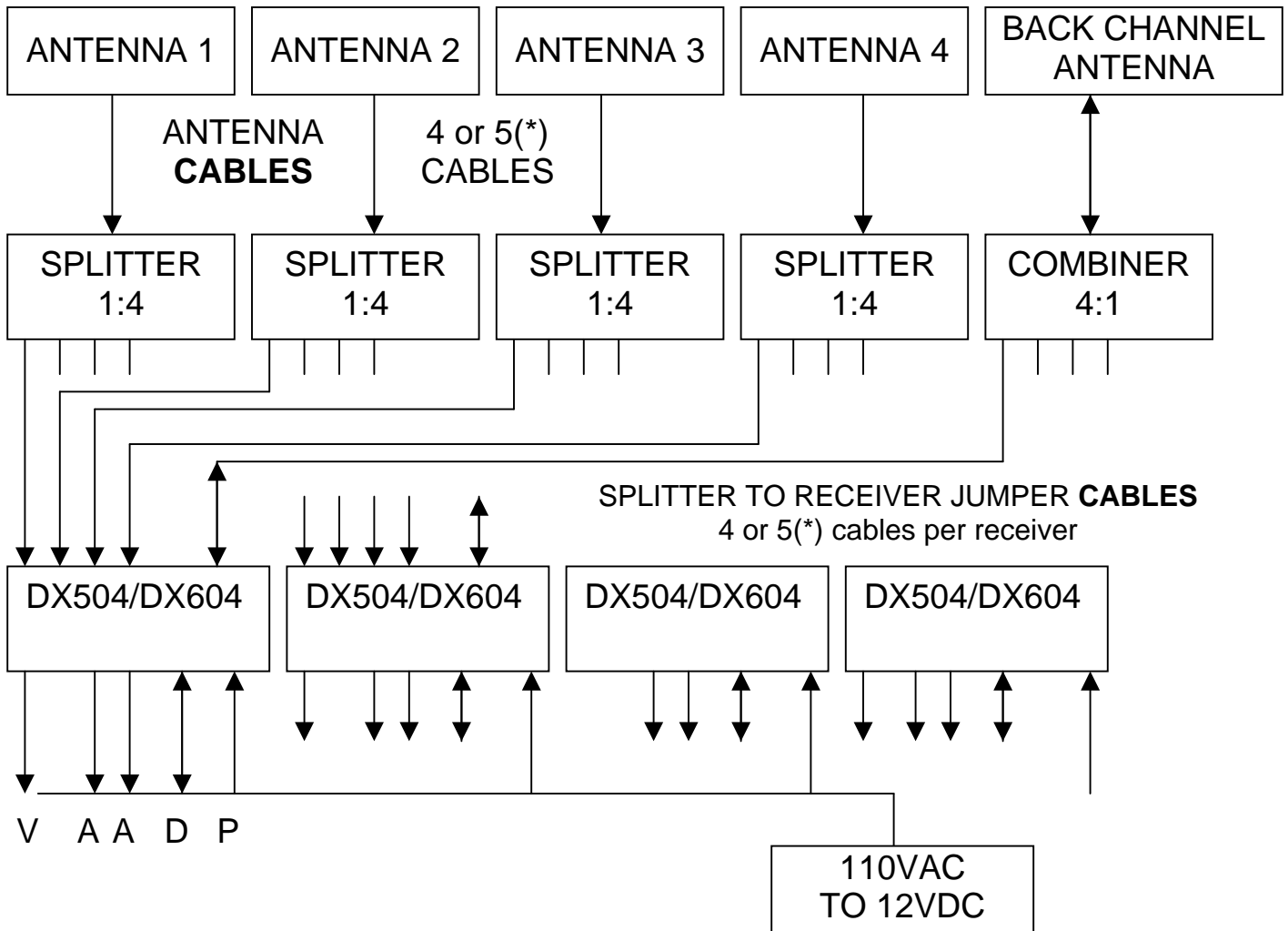

4/5(\*) **CABLES** per receiver

LINE

(\*) With BACK CHANNEL

**Figure J – Block Diagram of System  
 with  
 Four DX404/DX504/DX604 Receivers**

## Appendix A – LCD format

```
FFF.FFMHz SSSS  
MMMMMMMM NNRAIVL
```

← First line  
← Second line

DX404 LCD format

```
CH #17 SSSS  
MMMMMMMM NNRAIVL
```

← First line  
← Second line

DX404 LCD format # 2

```
FFFF.FFn aAa bBb  
MMMMMMMM NNRAIVL
```

← First line  
← Second line

DX504/DX604 LCD format

### A.1 The format of the first line is:

**FFFF.FF** is the carrier frequency

**SSSS** (DX404 only) is the video standard (PAL or NTSC).

**n** (DX504 only) is the video bandwidth: N = 16MHz  
W = 27MHz

**aAa** (DX504/DX604 only) is the audio1 sub-carrier frequency

**bBb** (DX504/DX604 only) is the audio2 sub-carrier frequency

Where **A** and **B** indicate the sub-carrier bandwidth: N=75KHZ  
W=150KHZ

## A.2 The format of the second line is:

**MMMMMMMM** is a warning prompt: INVALID = wrong entry  
BIT = system check  
MEM, I2C,KEY

**NN** is the receiver EIN (For the Optional remote control)

**R** is a single letter notifying: "P" Program mode, "R" Receive mode

**A** is a single letter notifying: "A" Automatic mode, "M" Manual mode

**I** is a single letter notifying: "N" = positive video, "I" negative video

**V** is a single letter notifying: "V" = video, "R" = video + audio

**L** is a single letter indicating that the keypad is locked

## Appendix B – Remote Programming Option

The DX404/DX504/DX604 can be remotely programmed via a:

- RS232C interface  
The data rate is set for 9600 Baud, 8 bits, no parity, 1 stop bit and no handshaking signals.

### B.1 Enabling the remote programming option.

On receipt of a valid command on the serial port, the DX604 enters the 'Remote/Programming' mode and the front panel keypad is 'locked'. The second line of the front panel LCD will display as follows:

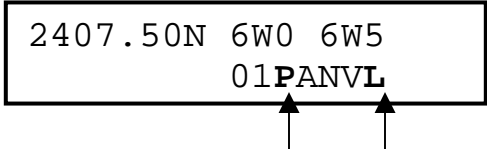

```
2407.50N 6W0 6W5
01PANVL
```

The **P** indicating the 'Remote or Programming' mode and the **L** indicating the locked keypad. To bring the unit back to front panel operation, the unlock command (\*055) can be sent on the serial bus or use the front panel keypad.

### B.2 Commands and responses

Commands sent to the DX604 should be terminated by the "carriage return" (0Dh) character, the "line feed" (0Ah) character, or the "carriage return" + "line feed" sequence.

If the command sent is valid, it will be executed and the new content of the LCD display is sent to the RS232C or IRDT interface, terminated by a carriage return + line feed. If the command is not valid, the sequence 'Error' is sent back.

Note: When ID is set, prefix all serial commands with the three-byte EIN sequence. Refer page 16

### B.3 List of Commands

- a) Frequency tuning: <FREQ><CR>
- b) Channel tuning: #<FREQ><CR>
- c) Frequency scanning step size: \*92<STEP><CR>
- d) Tuner Select: \*1# <TN><CR> (1 or more tuners)
- e) Turning ON or OFF the display: \*#<CR>
- f) Unlocking the keypad: \*055<CR>
- g) Tuning the audio sub-carrier frequencies (DX504/DX604 only):  
Audio1: \*21# <FREQ><CR>  
Audio2: \*22# <FREQ><CR>
- h) Setting the audio sub-carrier bandwidth:  
Audio1: \*211<CR> sets Audio1 bandwidth to Narrow.  
\*210<CR> sets Audio1 bandwidth to Wide.  
Audio2: \*221<CR> sets Audio2 bandwidth to Narrow.  
\*220<CR> sets Audio2 bandwidth to Wide.
- i) Changing the video bandwidth (DX504 only):  
\*32<CR> changes the video bandwidth to 27 MHz.  
\*31<CR> changes the video bandwidth to 16 MHz.
- j) Inverting the polarity of the video output:  
\*42<CR> sets the video output to negative video.  
\*41<CR> restores video output to positive video.
- k) Adding audio sub-carriers to the video output (DX504/DX604 only):  
\*51<CR> sets the video output to video with no audio.  
\*52<CR> sets the video output to video with audio.
- l) Assigning an EIN (Electronic Identification Number):  
\*8<EIN><CR> sets the EIN to the 2 digit number between 01 – 99  
\*8<CR> clears the EIN to 00 (No ID is set)

## **Appendix C – BIT Codes**

BIT 0 - memory error (unit is useable but will not retain stored setting)

BIT 1-4 and combinations thereof – the numbers indicate which tuners are unlocked (the unit needs to be returned to factory for repairs at the earliest). Partial functionality can be achieved (until unit can be taken out of service) by removing the unlocked tuner from the diversity temporarily using the \*1 command.

BIT 5 - I2C error. Unit is non-functional & must be sent back for repairs.

BIT 6/<KEY> - keypad error (a key may be stuck)